

# TORQUE BAR BEARINGS

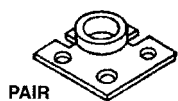

PAIR  
AWB 2  
DURALL-CENTRAL  
AUTO LOK

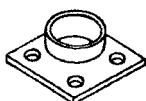

AWB 33  
CROWN

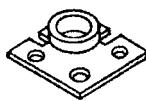

AWB 34  
NU AIRE



PAIR  
AWB 5  
PAN AM



AWB 6  
SUPERIOR

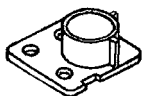

AWB 7  
MIAMI

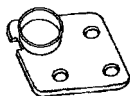

AWB 8  
HARCAR



AWB 18  
SILVERLINE



AWB 29  
YALE OGRON

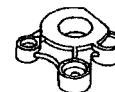

AWB 12  
AIR CONTROL

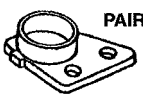

PAIR  
AWB 15  
CROSSLY

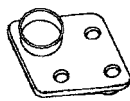

AWB 16  
CROWN

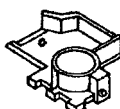

AWB 3  
AIRE LOK

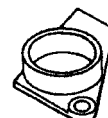

AWB 22  
TUCKER

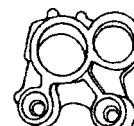

AWB 28  
KELLER  
CURRENT

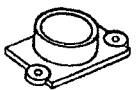

AWB 10  
LOOK (OLD)

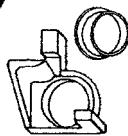

AWB 20  
AA

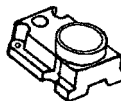

AWB 9  
LOOK

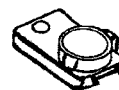

AWB 36  
HAR CAR  
OLD



AWB 35  
T M NEW

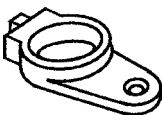

AWB 1  
TUCKER

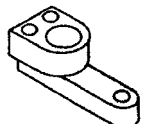

AWB 21  
RB LEONARD

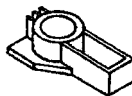

AWB 17  
VAR. MFG.

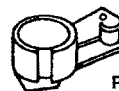

PAIR  
AWB 13  
STANLEY

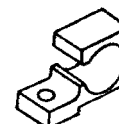

AWB 14  
LUDMAN

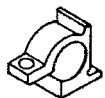

AWB 27  
WARE

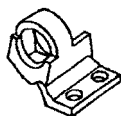

AWB 37  
ABC

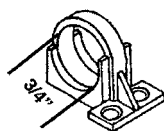

AWB 4  
ABC SADDLE

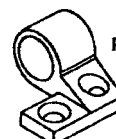

PAIR  
AWB 19  
LUDMAN

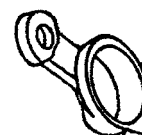

AWB 31  
ALCAN

IF IN DOUBT ON ANY PART -- SEND SAMPLE FOR IDENTIFICATION.  
WE ARE CONSTANTLY ADDING ADDITIONAL ITEMS TO SERVE YOU BETTER.

1E1  
SECTION E  
REV. 1/97



**REPLACEMENT HARDWARE Mfg., Inc.**

500 West 84 Street, Hialeah, FL 33014

(305) 558-5051 • FAX 305-557-5239 • NATIONAL 800-780-5051

TORQUE BAR BEARINGS

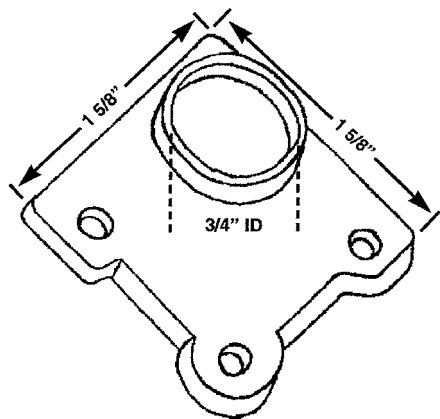

AWB 29  
YALE OGRON

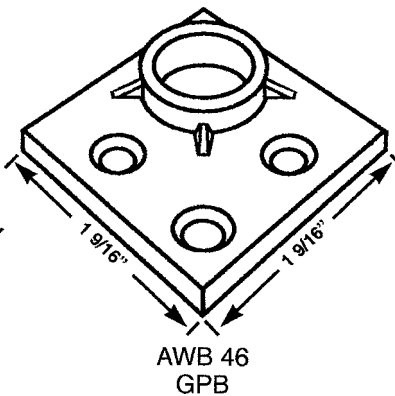

AWB 46  
GPB

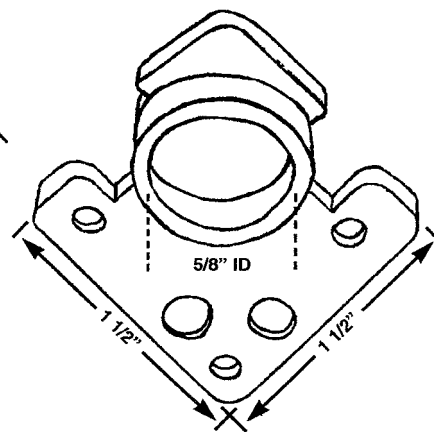

AWB 30  
ANDERSON

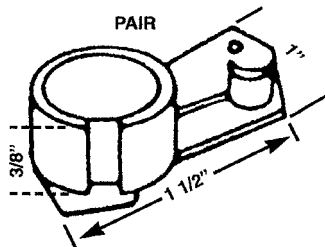

AWB 13  
STANLEY

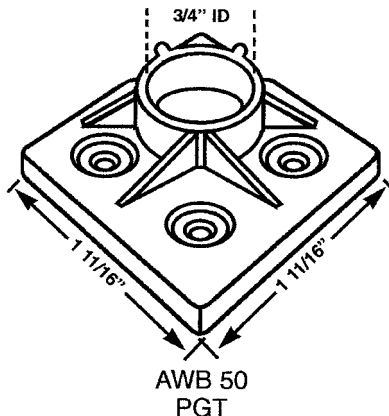

AWB 50  
PGT

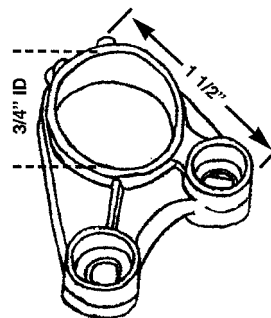

AWB 40  
AIR CONTROL 2

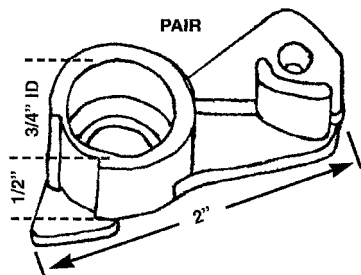

AWB 39  
CE

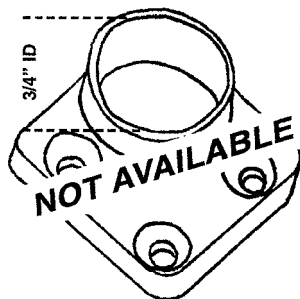

AWB 44

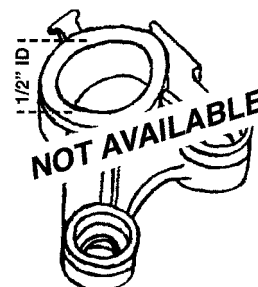

AWB 41  
OLD AIR CONTROL

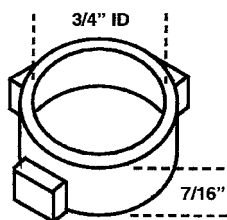

AWB 49

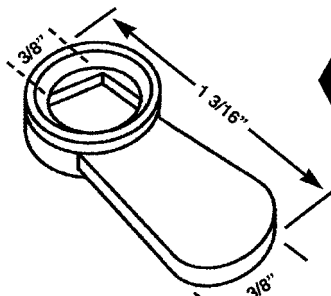

AWB 47

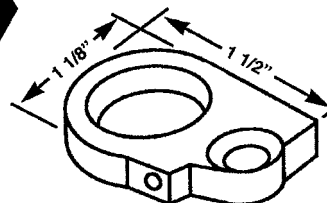

AWB 48  
TM '93

TORQUE BAR BEARINGS

**#1  
IN  
SERVICE**



**REPLACEMENT HARDWARE Mfg., Inc.**

500 West 84th Street ♦ Hialeah ♦ Florida 33014 ♦ USA  
305-558-5051 ♦ Fax: 305-557-5239 ♦ Toll Free: 1-800-780-5051  
www.rhmf.com ♦ www.replacement-hardware.com

1E2  
**SECTION E**  
REV. 12/02