

PUSH BARS & ACCESSORIES

AVAILABLE 12" & 16" LENGTHS
OTHER SIZES AVAILABLE
SPECIAL QUOTATION

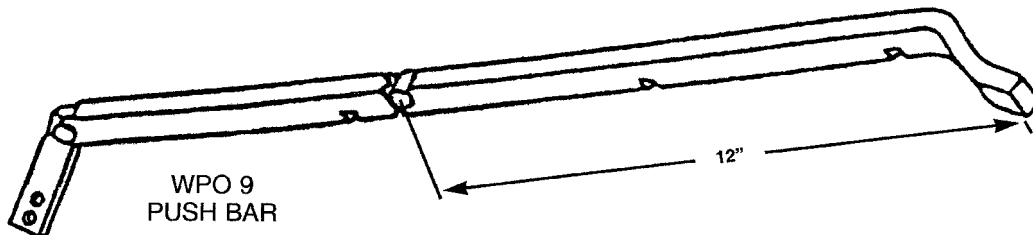

**WE'RE
#1
IN
SERVICE**

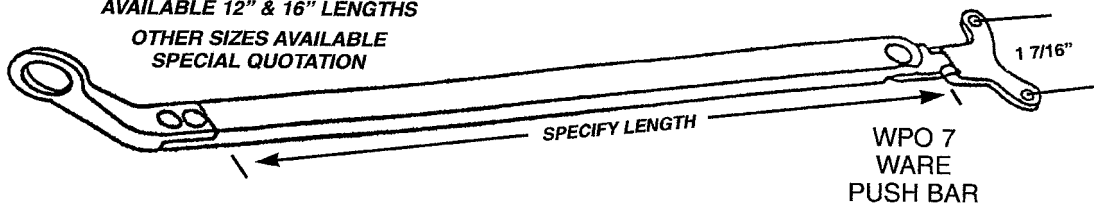
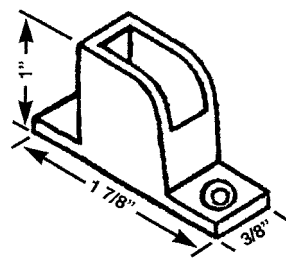
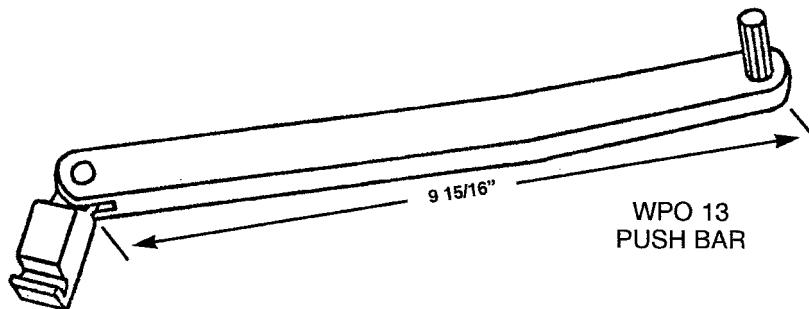
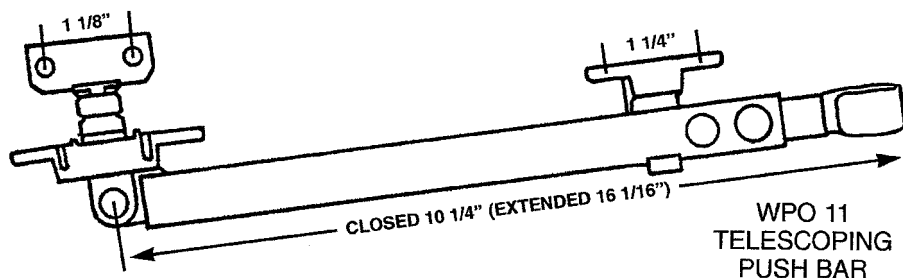

WPA 140
KEEPER

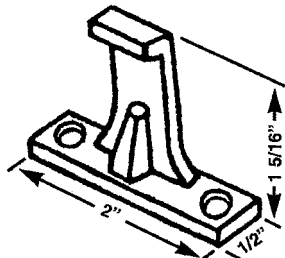

WPA 141
HOLDER

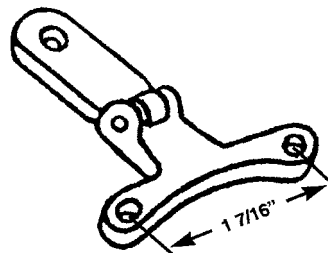

WPA 142
LINK

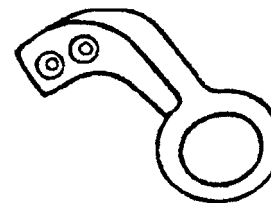

WPA 143
HANDLE

IF IN DOUBT ON ANY PART -- SEND SAMPLE FOR IDENTIFICATION
WE ARE CONSTANTLY ADDING ADDITIONAL ITEMS TO SERVE YOU BETTER

**#1
IN
SERVICE**



REPLACEMENT HARDWARE Mfg., Inc.

500 West 84th Street ♦ Hialeah ♦ Florida 33014 ♦ USA
305-558-5051 ♦ Fax: 305-557-5239 ♦ Toll Free: 1-800-780-5051
www.rhmfg.com ♦ www.replacement-hardware.com

4D1
SECTION D
REV. 8/01

PUSH BARS & ACCESSORIES