

LATCHES

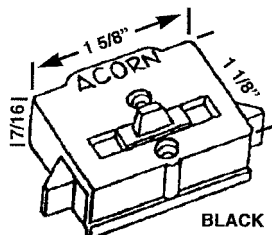

**HWP 286
TILT LATCH**

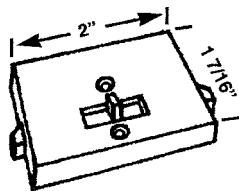

**HWP 750
SLIDE LATCH**

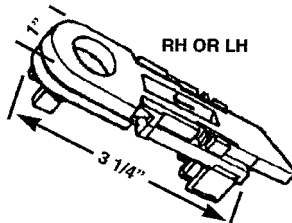

**HWL 52
SLIDE LATCH
BRACKET SPEC.**

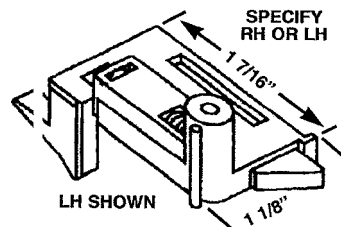

**HWP 720
ACORN
PIVOT LOCK ASMB**

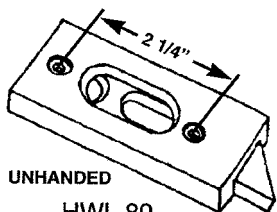

**UNHANDED
HWL 89
TILT LATCH**

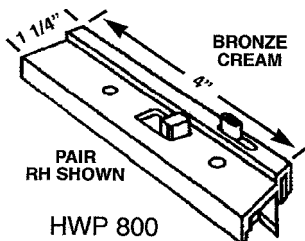

**PAIR
RH SHOWN
HWP 800
KINCO
S/H TILT LATCH**

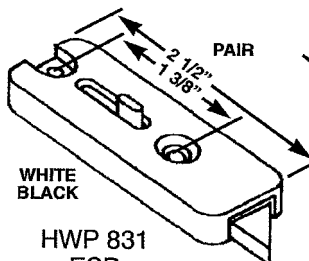

**WHITE
BLACK
HWP 831
ESP
LATCH**

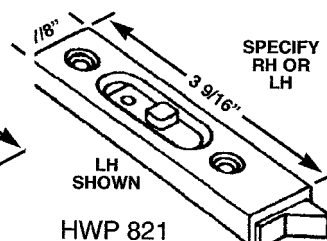

**LH SHOWN
HWP 821
TOP SASH
LATCH**

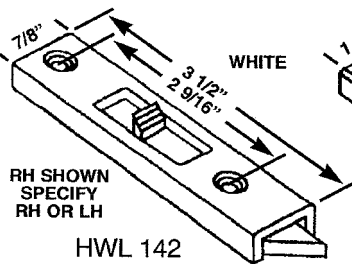

**WHITE
RH SHOWN
SPECIFY
RH OR LH
HWL 142
TILT LATCH**

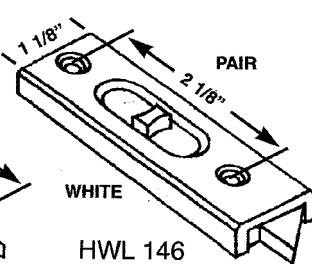

**WHITE
PAIR
HWL 146
ROLLYSON
TILT LATCH**

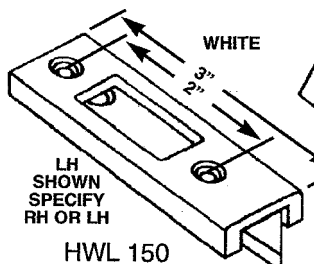

**WHITE
LH SHOWN
SPECIFY
RH OR LH
HWL 150
TILT LATCH**

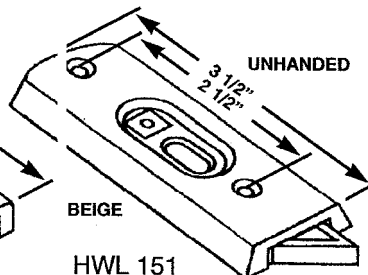

**UNHANDED
BEIGE
HWL 151
TILT LATCH**

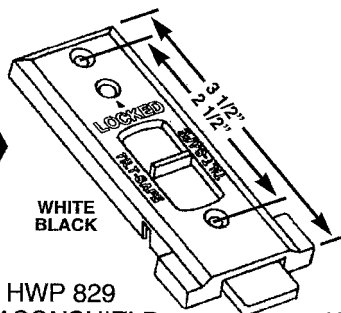

**WHITE
BLACK
HWP 829
SEASONSHIELD
TILT LATCH**

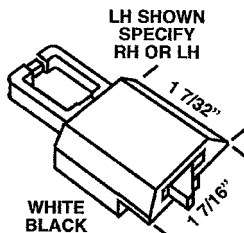

**LH SHOWN
SPECIFY
RH OR LH
HWP 700
KELLER SLIDE LATCH
TILT WINDOW**

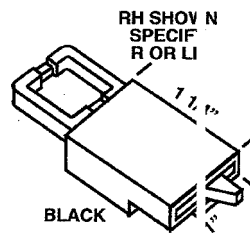

**RH SHOWN
SPECIFY
RH OR LH
BLACK
HWL 152
BINNINGS
TILT LATCH**

**Latches for
Hung & Sliding
Windows Are
Grouped
as Many Are
Interchangeable.**

**See Gold
Section 3 for
Horizontal Sliding
Window Hardware**

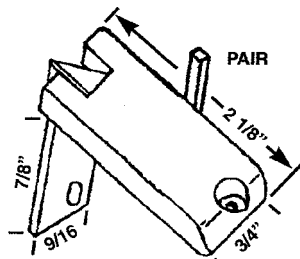

**PAIR
HWP 368
LATCH**

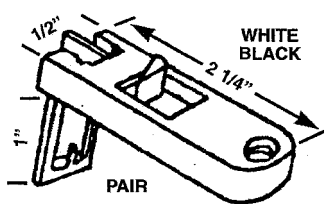

**WHITE
BLACK
PAIR
HWP 221
KELLER TILT LATCH**

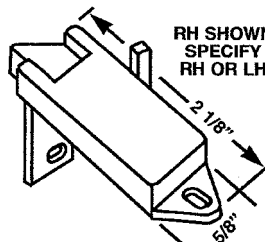

**RH SHOWN
SPECIFY
RH OR LH
HWP 803
ACORN PIVOT LATCH**

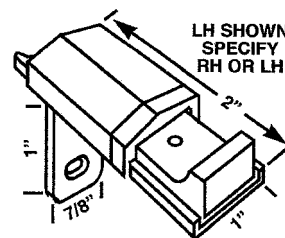

**LH SHOWN
SPECIFY
RH OR LH
HWP 789
TILT LATCH**

**2C1
SECTION C
REV. 11/02**



REPLACEMENT HARDWARE Mfg. Inc.

500 West 84th Street ♦ Hialeah ♦ Florida 33014 ♦ USA
305-558-5051 ♦ Fax: 305-557-5239 ♦ Toll Free: 1-800-781-5051
www.rhmf.com ♦ www.replacement-hardware.com

**#1
IN
SERVICE**

LATCHES

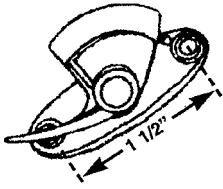

HWL 1
KELLER

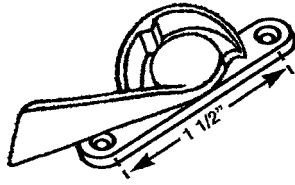

HWL 124
ORIGINAL KELLER
OLD STYLE

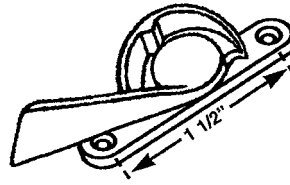

HWL 2
AIR CONTROL

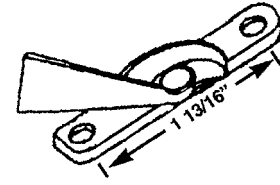

HWL 15
CROFT

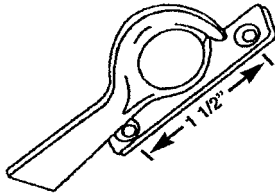

HWL 87
SWEEP LATCH

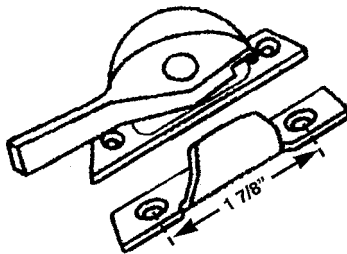

HWL 120
WOOD WINDOW SET

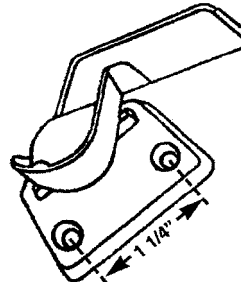

HWL 99
NUPRIME

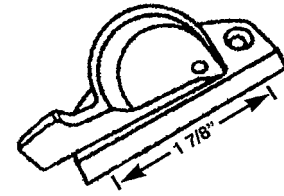

HWL 125
AAA

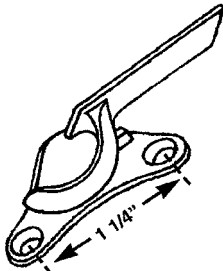

HWL 9
SWEEP LATCH

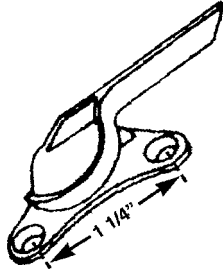

HWL 25
SWEEP LATCH

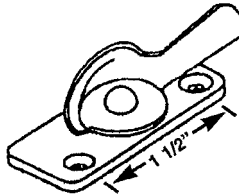

HWL 23
UALCO OLD TYPE
SWEEP LATCH

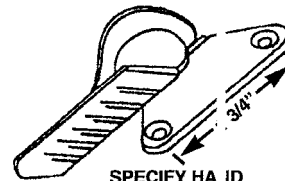

HWL 100

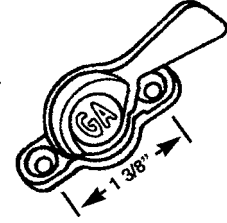

HWL 118
G/A
SWEEP LATCH

LATCHES FOR HUNG & SLIDING WINDOWS ARE GROUPED, AS MANY ARE INTERCHANGEABLE.

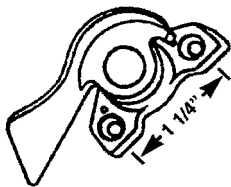

HWL 94
GBP S/H 60

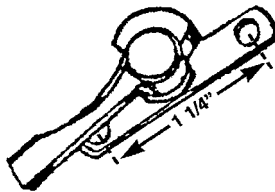

HWL 72
RUSCO

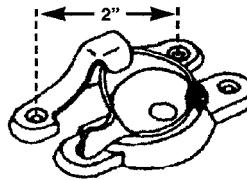

HWL 82
SASH LOCK
W/KEEPER

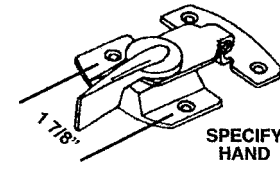

HWL 81
AIR CONTROL

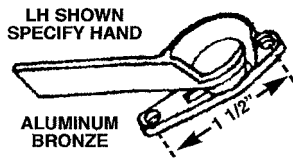

HWL 3
PAN AM

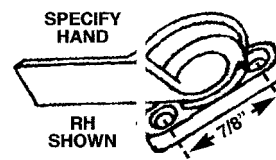

HWL 4
STANLEY



REPLACEMENT HARDWARE Mfg. Inc.

500 West 84 Street, Hialeah, FL 33014

(305) 558-5051 • FAX 305-557-5239 • NATIONAL 800-730-5051

2C2
SECTION C
REV. 1/99

LATCHES

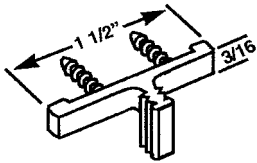

HWL 140
IDA
SLIDE BUTTON

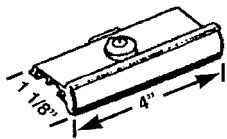

HWL 78
HANDLE

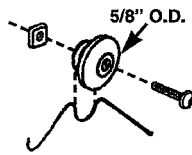

HWL 77
REPLACEMENT KIT

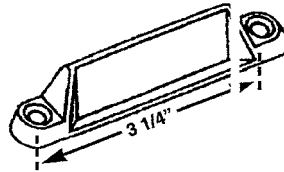

HWP 735
LIFT HANDLE

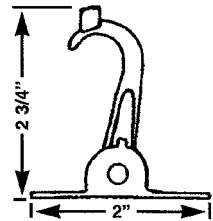

HWL 56
CROSSLY PULL

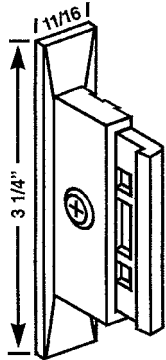

HWL 51
M.H.
SLIDE
LATCH

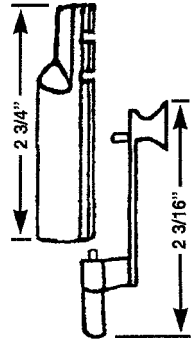

HWL 46
LOCKING
LATCH



HWL 71
VENT
LATCH

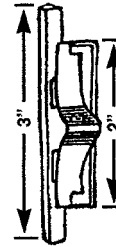

HWL 59
CROSSLY
SLIDER

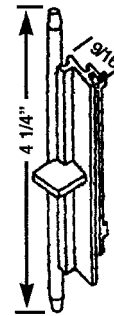

HWL 83
SLIDE
BOLT
LOCK

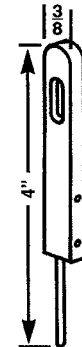

HWL 139
IDA H100
SLIDE
LATCH

AVAILABLE IN: WHITE BRONZE (SILVER COLOR)

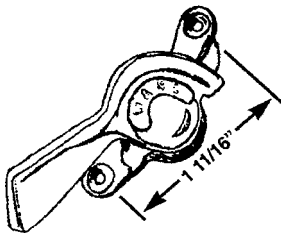

HWL 30
WARE

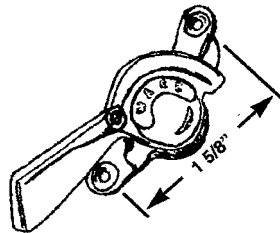

HWL 67
SECURITY LATCH

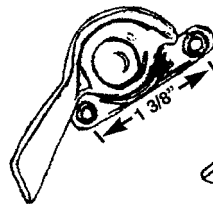

HWL 75
KESCO

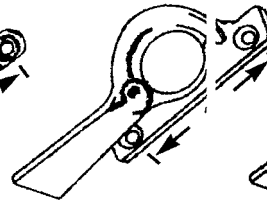

HWL 65
SWEEP LATCH

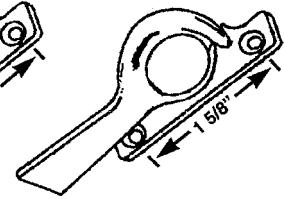

HWL 66
SWEEP LATCH

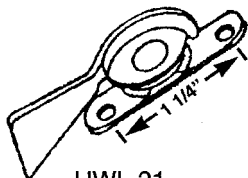

HWL 21
PORTERFIELD
SUPERIOR

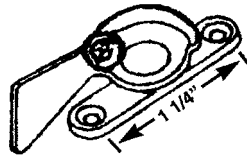

HWL 62
SECURITY LATCH

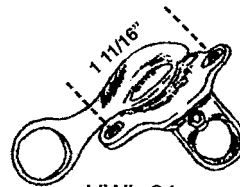

HWL 64
POLE EYE

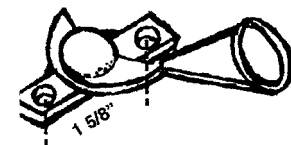

HWL 74
POLE EYE

LATCHES FOR HUNG
& SLIDING WINDOWS
ARE GROUPED
AS MANY ARE
INTERCHANGEABLE

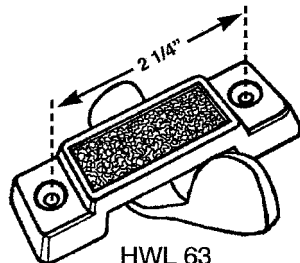

HWL 63

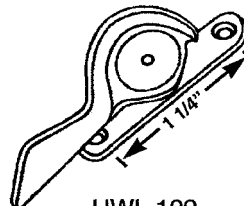

HWL 129

IF IN DOUBT ON ANY PART
SEND SAMPLE FOR
IDENTIFICATION.
WE ARE CONSTANTLY
ADDING ADDITIONAL ITEMS
TO SERVE YOU BETTER.



LATCHES

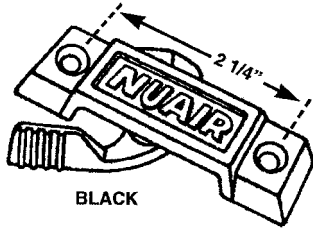

BLACK

HWL 101
NUAIRE H.R.

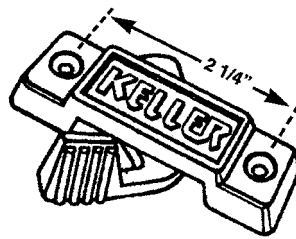

HWL 107
KELLER

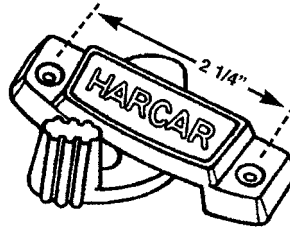

HWL 111
HARCAR SWEEP

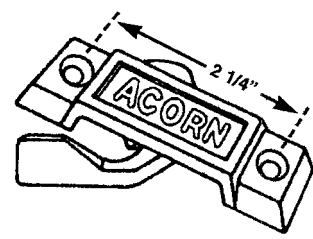

HWL 113
ACORN

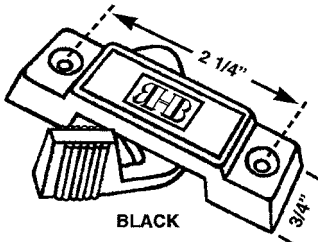

BLACK

HWL 137
CLEARVIEW (RHB)
NYLON

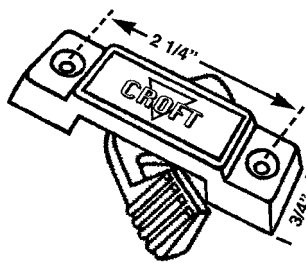

HWL 134
CROFT

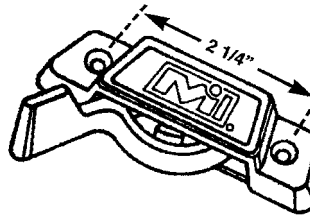

HWL 121
MI

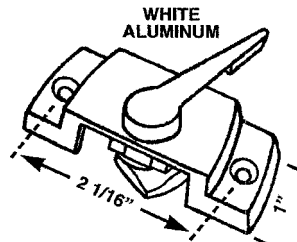

WHITE
ALUMINUM
HWL 132
SECURITY '96

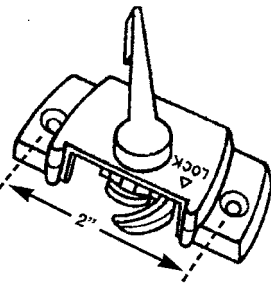

HWL 122
TRUTH

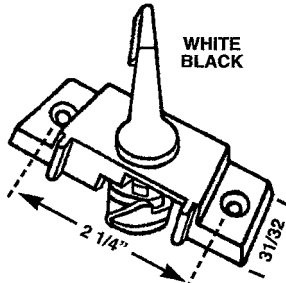

WHITE
BLACK

HWL 153
BINNINGS

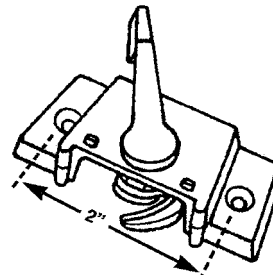

HWL 123
WINDOW

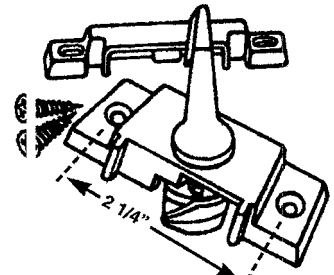

HWL 114
ALCAN
LATCH & KEEPER

LATCHES

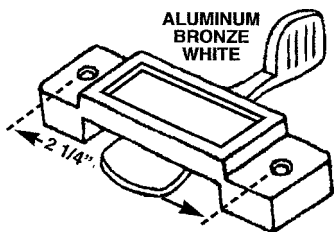

ALUMINUM
BRONZE
WHITE

HWL 14

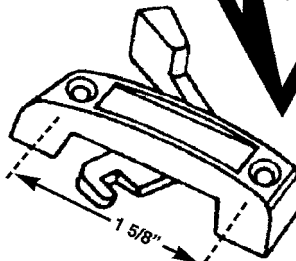

HWL 117

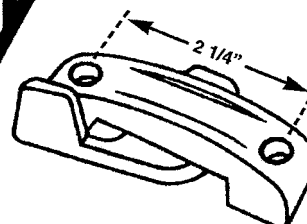

HWL 110

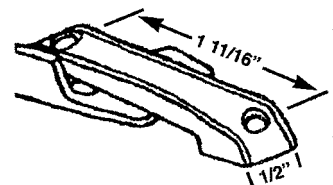

HWL 45
NU AIRE

IF IN DOUBT ON ANY PART -- SEND SAMPLE FOR IDENTIFICATION.
WE ARE CONSTANTLY ADDING ADDITIONAL ITEMS TO SERVE YOU BETTER.

#1
IN
SERVICE



REPLACEMENT HARDWARE Mfg. Inc.

500 West 84th Street ♦ Hialeah ♦ Florida 33014 ♦ JSA
305-558-5051 ♦ Fax: 305-557-5239 ♦ Toll Free: 1-800-781-5051
www.rhmf.com ♦ www.replacement-hardware.com

2C4
SECTION C
REV. 1/99

LATCHES

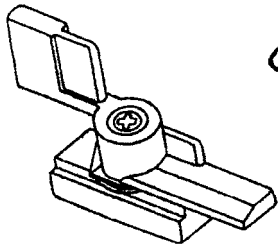

HWL 43
CROSSLY
SLIDER

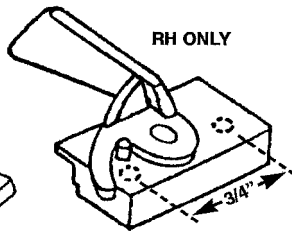

HWL 6
CROSSLY
SLIDER

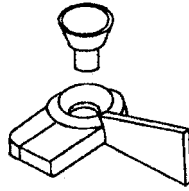

HWL 5
HWL 18
OPPOSITE HAND

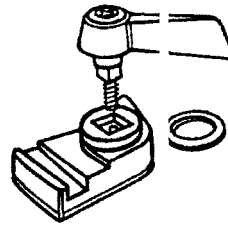

HWL 109L
HARCAR 140
LONG

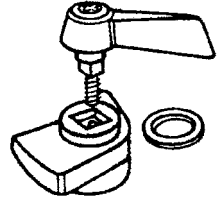

HWL 109S
HARCAR 440
SHORT

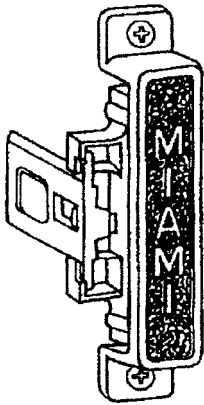

HWL 95
MIAMI
WINDOW

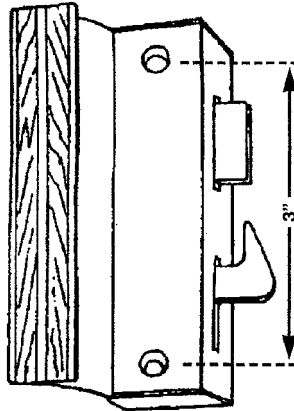

HWL 88
SURFACE
MOUNT

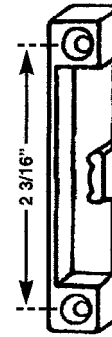

HWL 10
SURFACE
MOUNT

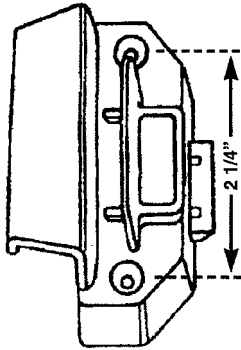
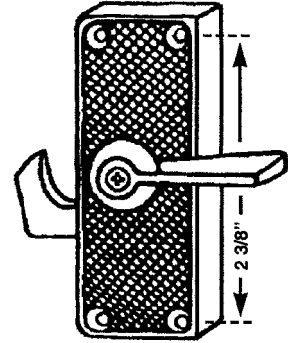

HWL 108
LATCH

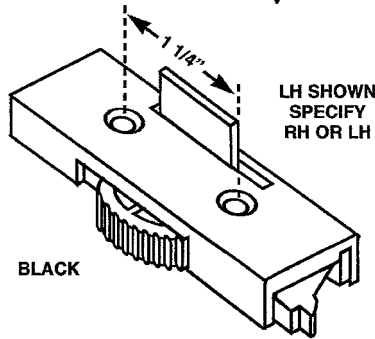

HWL 154
MILCO TILT LATCH



HWL 119
KELLER

IF IN DOUBT ON ANY PART -- SEND SAMPLE FOR IDENTIFICATION.
WE ARE CONSTANTLY ADDING ADDITIONAL ITEMS TO SERVE YOU BETTER.

LATCHES

2C5
SECTION C
REV. 1/99



REPLACEMENT HARDWARE Mfg. Inc.

500 West 84th Street ♦ Hialeah ♦ Florida 33014 ♦ USA
305-558-5051 ♦ Fax: 305-557-5239 ♦ Toll Free: 1-800-780-5051
www.rhmfg.com ♦ www.replacement-hardware.com

**#1
IN
SERVICE**

LATCHES

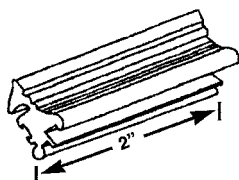

HWL 80
AC HORIZONTAL
SLIDER

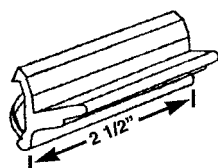

HWL 79
WALLACE
CROSSLY

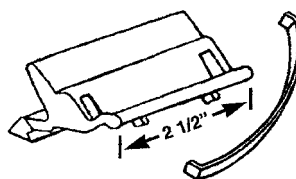

HWL 58
CROSSLY
SH LATCH

BRONZE
EGGSHELL

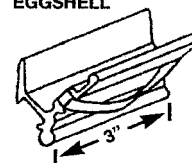

HWL 84
KINCO
TILT LATCH

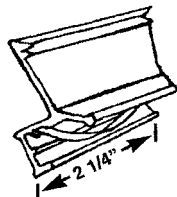

HWL 60
ACORN

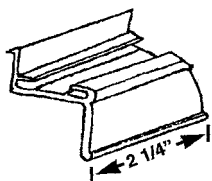

HWL 61
ACORN

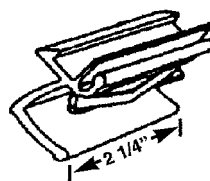

HWL 68
ACORN
300

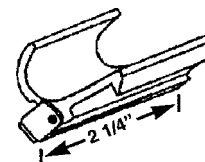

HWL 73
TEXAS
AC

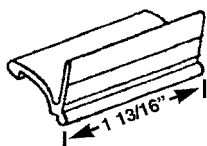

HWL 54
BARRINGTON
ALUMINUM

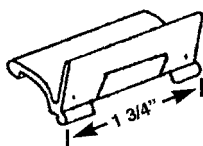

HWL 8
BARRINGTON
NU AIRE

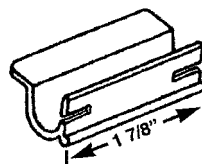

HWL 13
LOOK

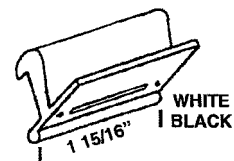

HWL 20
YALE OGRON

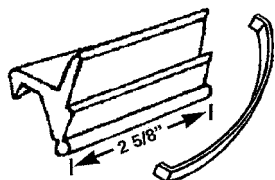

HWL 57
THERMALUME

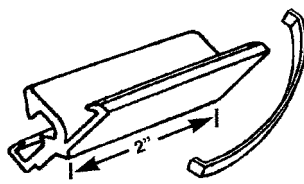

HWL 27
CROSSLY

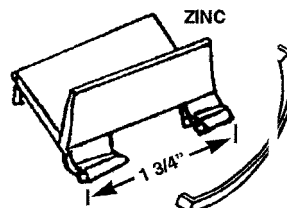

HWL 44
NU AIRE

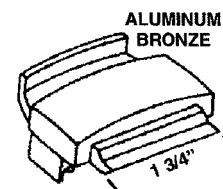

HWL 31
CROSSLY
SLIDER

IF IN DOUBT ON ANY PART -- SEND SAMPLE FOR IDENTIFICATION.
WE ARE CONSTANTLY ADDING ADDITIONAL ITEMS TO SERVE YOU BETTER.



REPLACEMENT HARDWARE Mfg. Inc.

500 West 84 Street, Hialeah, FL 33014

(305) 558-5051 • FAX 305-557-5239 • NATIONAL 800-730-5051

2C6
SECTION C
REV. 1/89

LATCHES

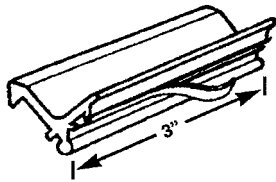

HWL 104
LATCH

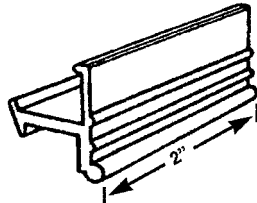

HWL 112
LATCH

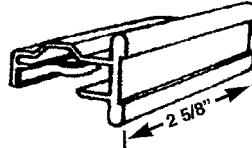

HWL 126
LATCH

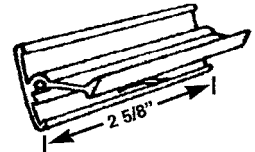

HWL 127
LATCH

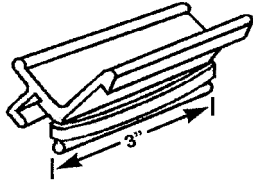

HWL 135
LATCH

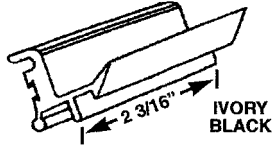

HWL 147
ROLLYSON
500 SERIES

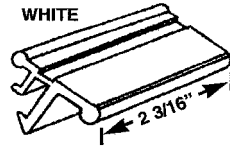

HWL 149
ROLLYSON
2000 SERIES

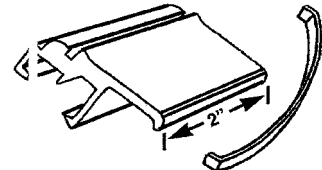

HWL 144
ROLLYSON
3000 SERIES LOCK

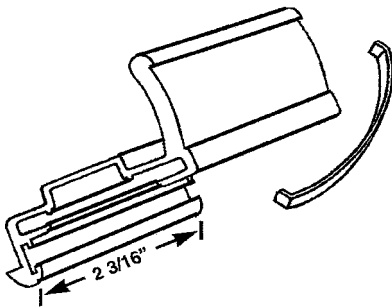

HWL 35
ACORN
MILL

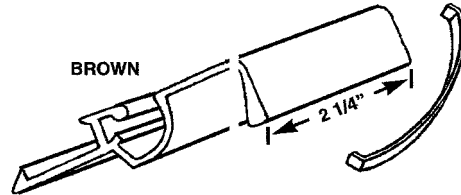

HWL 34 BR
ACORN
2330 SERIES

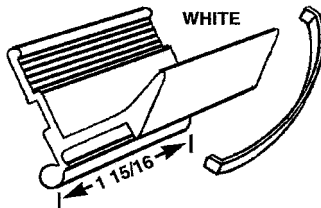

HWL 138
SW

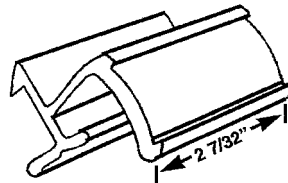

HWL 148
ACORN
3500 SERIES

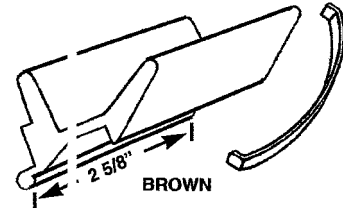

HWL 145
KINCO
W/SPRING

IF IN DOUBT ON ANY PART -- SEND SAMPLE FOR IDENTIFICATION.
WE ARE CONSTANTLY ADDING ADDITIONAL ITEMS TO SERVE YOU BETTER.

