

# SLIDING SCREEN DOOR KEEPERS

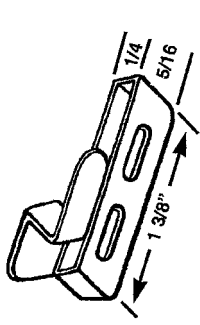

PSL 201  
HANDED  
KEEPER

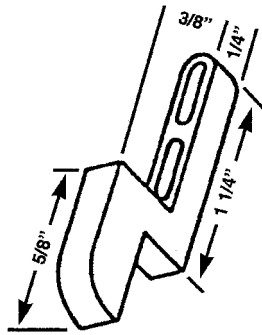

PSL 202  
KEEPER

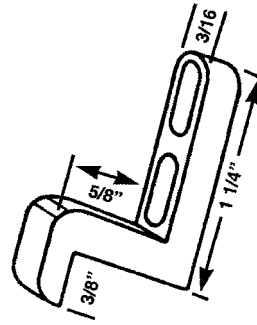

PSL 213  
DIE CAST  
KEEPER

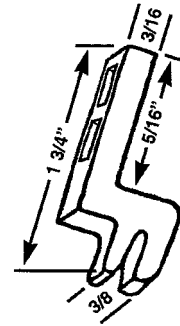

PSL 204  
UNIVERSAL  
NYLON

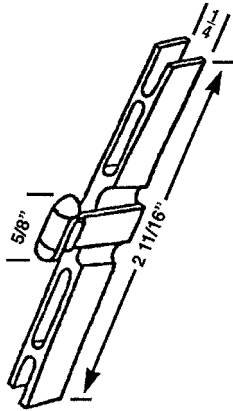

PSL 206  
NYLON  
KEEPER

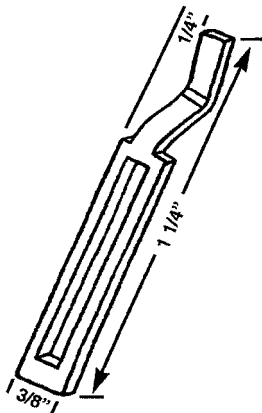

PSL 208  
STAMPED  
KEEPER

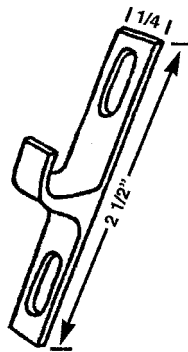

PSL 210  
MILLER  
EXTRUDED

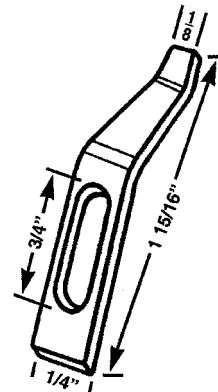

PSL 214  
STAMPED  
KEEPER

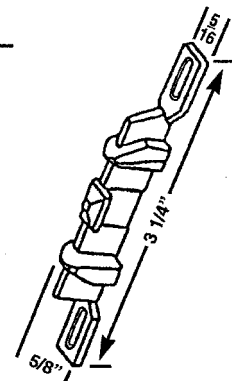

PSL 215  
KEEPER  
FOR PSL 63

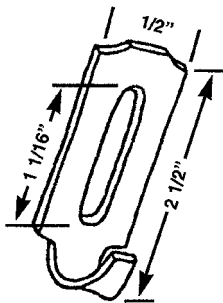

PSL 209  
COLUMBIA  
STRIKE

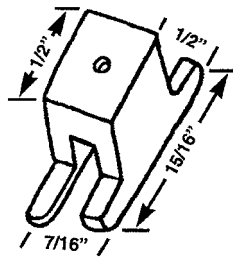

PSL 211  
PAN AM  
KEEPER

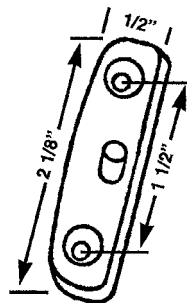

PSL 216  
HOWARD  
KEEPER

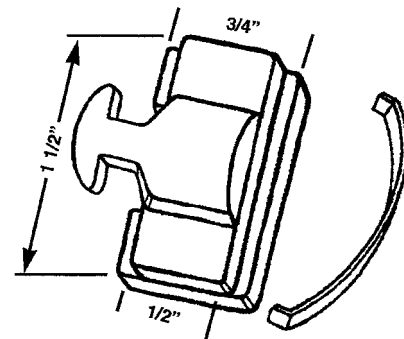

PSL 217  
CROSSLY/IDA  
SCREEN  
LATCH

IF IN DOUBT ON ANY PART -- SEND SAMPLE FOR IDENTIFICATION.  
WE ARE CONSTANTLY ADDING ADDITIONAL ITEMS TO SERVE YOU BETTER.



**REPLACEMENT HARDWARE Mfg., Inc.**

500 West 84 Street, Hialeah, FL 33014

(305) 558-5051 • FAX 305-557-5239 • NATIONAL 800-780-5051

6B3  
**SECTION B**  
REV. 1/98